

FRONT VIEW

18"X18" SIDE HINGED
A/D U.L. APPROVED

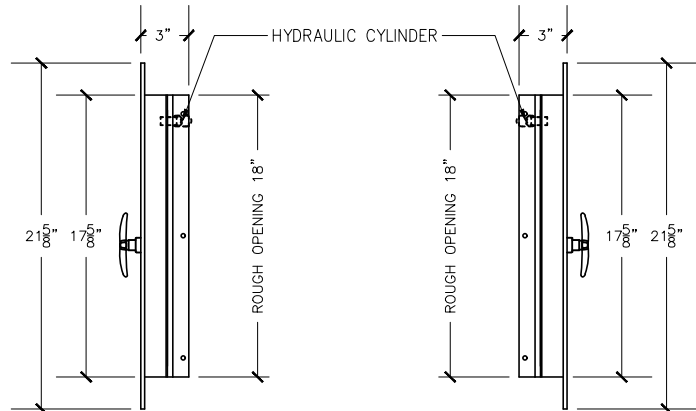

RIGHT VIEW

LEFT VIEW

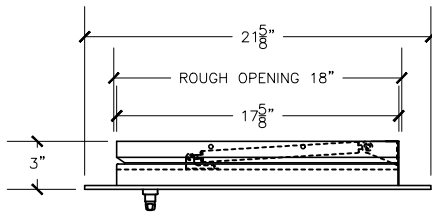

TOP VIEW

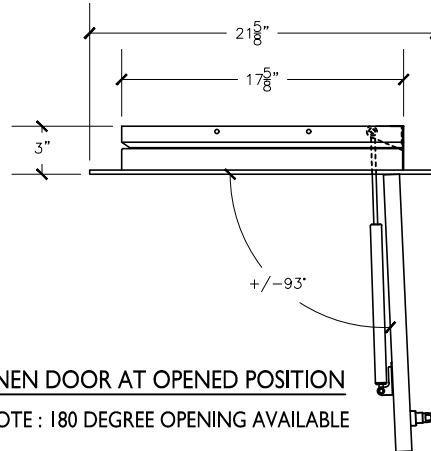

LINEN DOOR AT OPENED POSITION

NOTE : 180 DEGREE OPENING AVAILABLE

Linen chute door specifications:

Doors are fabricated with type 304 Stainless Steel, Stainless Steel Hinges, with a self closing, self latching quiet door closing function. Class B labeled: 1-1/2 hour fire rated with 30-minute temperature rise of 250 degrees Fahrenheit and a frame suitable for enclosing multiple type chase construction. Doors are provided with key locking devices at each intake door location. Door trim is embossed "LINEN".

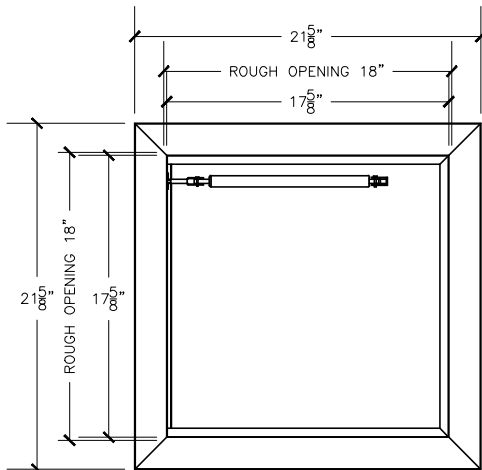

REAR VIEW

NOTE:

Rough opening required 18"x18"



10345 NW 13th Manor
Coral Springs, FL 33071
T: (954) 501-5161

E: esales@trashlinenchutes.com
www.trashlinenchutes.com

TRASHLINENCHUTES
QUALITY TRASH, LINEN & RECYCLING PRODUCTS

LINEN CHUTE INTAKE DOOR
MODEL # 25L2-90D 18"X18" LD/RH 2" TRIM