

FRONT VIEW
18"x18" SIDE HINGED
A/D U.L. APPROVED

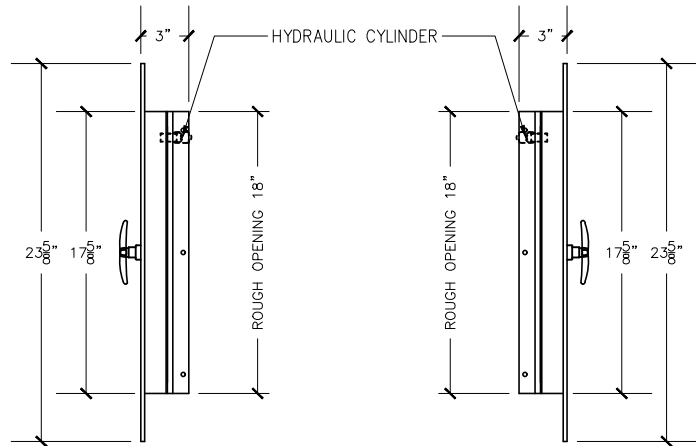

RIGHT VIEW **LEFT VIEW**

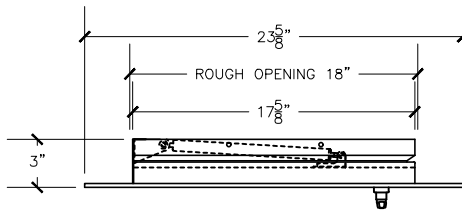

TOP VIEW

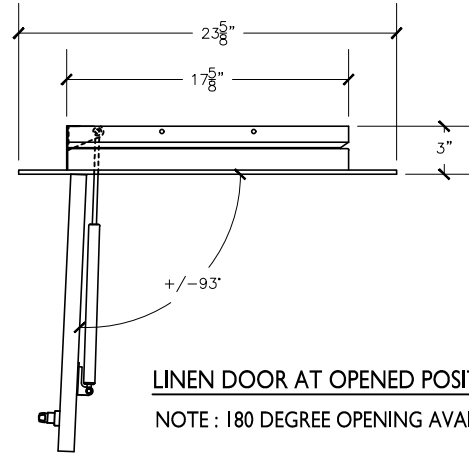

LINEN DOOR AT OPENED POSITION
NOTE : 180 DEGREE OPENING AVAILABLE

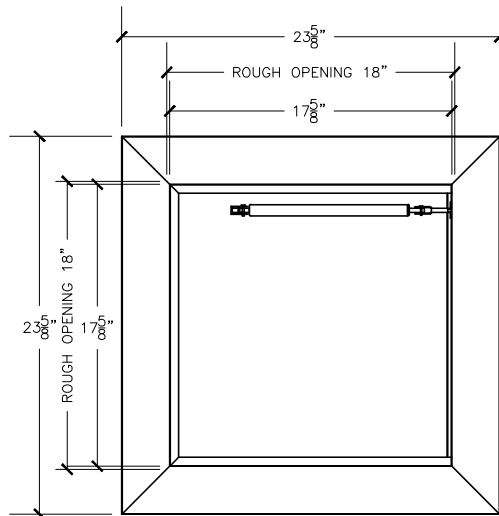

REAR VIEW

NOTE:
Rough opening required 18"x18"

Linen chute door specifications:

Doors are fabricated with type 304 Stainless Steel, Stainless Steel Hinges, with a self closing, self latching quiet door closing function. Class B labeled: 1-1/2 hour fire rated with 30-minute temperature rise of 250 degrees Fahrenheit and a frame suitable for enclosing multiple type chase construction. Doors are provided with key locking devices at each intake door location. Door trim is embossed "LINEN".

10345 NW 13th Manor
Coral Springs, FL 33071
T: (954) 501-5161

E: esales@trashlinenchutes.com
www.trashlinenchutes.com

TRASHLINENCHUTES
QUALITY TRASH, LINEN & RECYCLING PRODUCTS

LINEN CHUTE INTAKE DOOR
MODEL # 25L3-90D 18"x18" LD/LH 3" TRIM